

Digital Ebook



A RESOURCE ON ELECTRIC LINEAR ACTUATORS

What a machine designer needs to know

Sold & Serviced By
 **ELECTROMATE**
Toll Free Phone (877) SERV099
Toll Free Fax (877) SERV099
www.electromate.com
sales@electromate.com

CONTRIBUTOR CREDITS

There were many talented Tolomatic contributors responsible for the contents of this ebook. Thank you to:

GARY ROSENGREN, director of engineering;

IGOR GLIKIN, senior mechanical engineer;

PATRICK HOBART, senior software development engineer;

SCOTT KLAR, electrical engineer;

AARON DIETRICH, director of marketing;

RYAN KLEMETSON, target markets manager;

DAN CASS, director of business development;

and all the support staff that helped produce the materials contained in this e-book. We hope you find the contents informative.

P.3 I. WHY ELECTRIC ACTUATORS? EVALUATING THE BASICS

- a. What is a linear actuator?
- b. Electric linear actuator advantages

P.4 II. ACCURACY AND REPEATABILITY: CRITICAL CONCEPTS

P.5 III. SELECTING THE RIGHT ACTUATOR: ROD OR RODLESS

- a. Rod actuators
- b. Rodless electromechanical actuators
- c. Screw selection
- d. Consider the environment
- e. Comparing manufacturers' specs
- f. Calculating actuator life

P.11 IV. MOTOR SELECTION: STEPPER OR SERVO?

- a. Stepper motors
- b. Servo motors
- c. Motor mounting

P.13 V. SYSTEM INSTALLATION: CONSIDERATIONS

- a. Optimizing actuator alignment
- b. Minimizing electrical noise

P.14 VI. ELECTRIC ACTUATOR APPLICATIONS: IMPROVED EFFICIENCY

- a. Automotive manufacturing
- b. Process industries
- c. Food and beverage processing
- d. Material handling

P.16 VII. CONCLUSION: TOTAL COST OF OWNERSHIP

Sold & Serviced By:

 **ELECTROMATE**

Toll Free Phone (877) SERV098

Toll Free Fax (877) SERV099

www.electromate.com

sales@electromate.com

 **Tolomatic**
EXCELLENCE IN MOTION

I. Why electric actuators? Evaluating the basics

COURTESY OF TOLOMATIC

BLOG

Subscribe to Tolomatic's blog to learn more about actuators and linear motion.



WHAT IS A LINEAR ACTUATOR?

A linear actuator is defined as a device that creates motion in a straight line. These devices are used in automotive manufacturing, process industries, food and beverage processing, material handling, robotics, and in other places where linear motion is required.

Industrial applications use pneumatic-, hydraulic- and electric-powered linear actuators. Pneumatic and hydraulic power produce linear motion naturally so pneumatic and hydraulic linear actuators (often called cylinders) can be fairly simple devices. However, in electric-powered linear actuators an electric motor's rotary motion must be converted to linear motion through a screw/nut system or a belt. This means electric linear actuators are somewhat more complex devices than pneumatic or hydraulic actuators but can offer significant advantages in many applications.

ELECTRIC LINEAR ACTUATOR ADVANTAGES

The decision of whether to use an electric, [pneumatic](#) or hydraulic linear actuator is a crucial one for engineers when specifying a linear actuator. A pneumatic cylinder has advantages — ease-of-use, lower cost — but carries with it inefficiencies in operation with potential compressed air leaks. A hydraulic cylinder can provide high-thrust capabilities in a variety of environments, but they can be prone to fluid leaks which are not environmentally friendly.

An electric linear actuator can offer distinct benefits:

- **Able to handle complex motion profiles** — Motion control systems have become more complicated. Electric linear actuators can provide precise control of speed, acceleration, deceleration and force, outperforming fluid power technologies. They offer accuracy/repeatability, infinite positioning capabilities with data feedback and are able to handle complex motion profiles.
- **Able to adapt to changing needs** — An electric actuator's programming can be changed. If parameters change, the actuator can be adjusted to meet new specifications with minimal downtime and loss of productivity.
- **Lower lifetime cost with highest efficiency and lowest energy use** — Electric-powered systems operate at 70-80% total system efficiency, compared to 40-55% for hydraulic and 10-15% for pneumatic systems. In fact, savings over the total life cycle cost of the actuator—including the savings in efficiency, energy use and reduced maintenance—can far outweigh the initial acquisition cost.
- **Readily integrate into other electric production systems** — Electric actuators are easily integrated into motion control systems with the use of PLCs, HMIs and other devices to offer enhanced motion control, data collection and diagnostics. 🔄

II. Accuracy and repeatability: Critical concepts

COURTESY OF TOLOMATIC

When discussing a linear motion application, many users ask "How accurate is this actuator?" The answer is more involved than simply stating a number.

Accuracy and repeatability are related but not the same. Accuracy refers to the ability of an actuator to achieve a commanded position. Repeatability refers to the ability of the actuator to achieve a position time after time.

The relative importance of the two qualities depends on a thorough understanding of your application. Positional errors can come from several sources: the actuator itself, the motor and its encoder, and the motor driver. Also, the way an actuator is deployed has significant influence on the results.

There are numerous actuator styles/types manufactured to various degrees of precision and subsequent cost. There are also models that have high repeatability without high accuracy. In the right application these less accurate and lower-priced models can deliver excellent performance.

The key to success is understanding what is required in your application and choosing the actuator accordingly. By doing so, you can avoid excess costs and design a system with the best overall value. 🔄

WHITE PAPER DOWNLOAD:

Download our whitepaper, *Introduction to accuracy and repeatability in linear motion systems*, for a thorough explanation.

www.tolomatic.com

Accuracy and Repeatability in Linear Actuators

Separate, but related, concepts



High Accuracy AND High Repeatability

Accuracy is the ability of a linear actuator to reach a commanded position. If an actuator is highly accurate, it will exhibit a high degree of repeatability as well.



High Repeatability, but Lower Accuracy

Repeatability is the ability of a linear actuator to reach the same position time after time. Repeatability is often what's needed in an application rather than accuracy.



Lower Accuracy and Lower Repeatability

There are applications where positioning tolerances are wider. In those instances lower degrees of accuracy and repeatability are acceptable.

© 2015 TOLOMATIC

Sold & Serviced By:

 **ELECTROMATE**

Toll Free Phone (877) SERV098

Toll Free Fax (877) SERV099

www.electromate.com

sales@electromate.com

SPONSORED BY



III. Selecting the right actuator: Rod or rodless

COURTESY OF TOLOMATIC

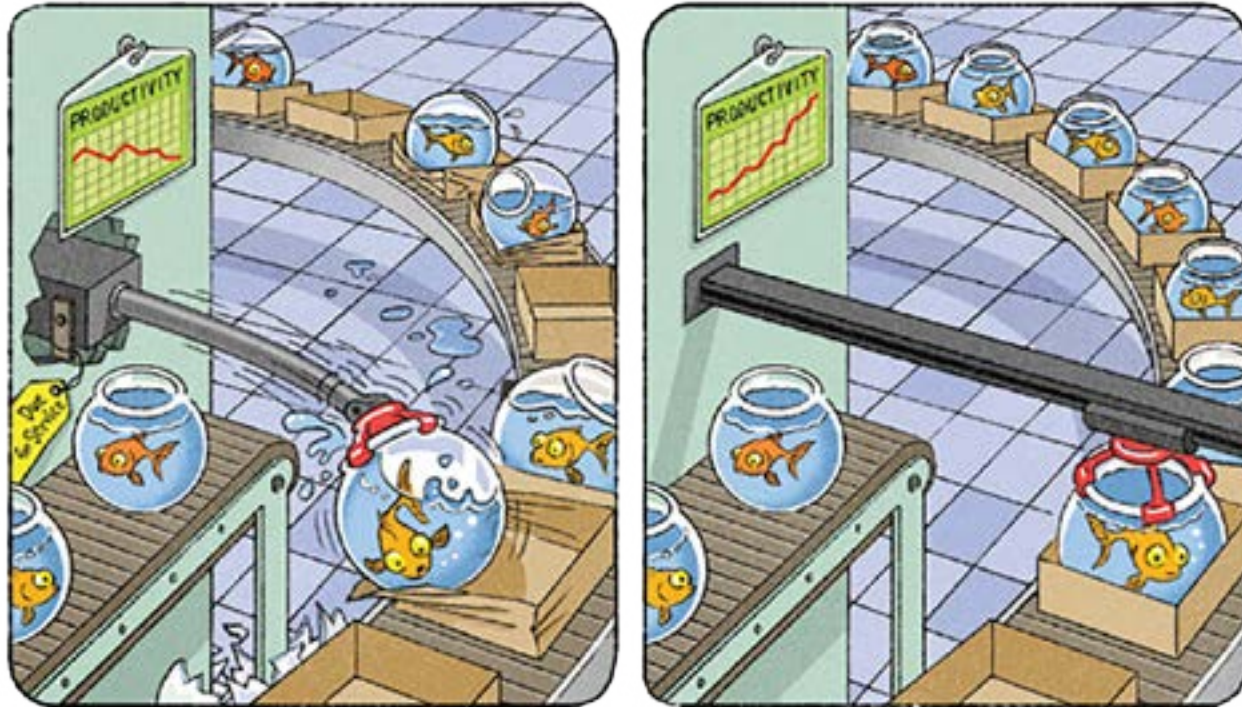

When you need to specify an electric linear actuator, begin by answering these simple questions:

- What needs to be moved?
- How far and fast does it have to move?
- How much does the load weigh?
- How much space is available for the system?
- What are the force requirements?

The answers will make actuator selection easier and lead you to the initial decision of whether to specify an electric rod actuator or a rodless electromechanical actuator.

The pushing action of an electric rod actuator

works well in many applications. However, this type of actuator may not be suitable if the item is heavy and must be supported or if the distance traveled is long. Rod-style actuators do not provide support to a load. The weight of the load can deflect the rod, causing wear on seals and bearings and even triggering major positioning problems.

Rodless actuators guide and support the load throughout the stroke length. They also have a size advantage because their entire stroke length is contained in their body rather than having a rod that extends out from the body. However, these actuators may not stand up to harsh environments without shielding.

Sold & Serviced By:

 **ELECTROMATE**

Toll Free Phone (877) SERV098

Toll Free Fax (877) SERV099

www.electromate.com

sales@electromate.com

Selecting the right actuator: Rod or rodless

(CONTINUED)

ROD ACTUATORS

SELECTION TIPS

Factory automation applications are requiring faster speeds and greater precision, so machine designers are changing to electric linear actuators. Electric rod actuators can deliver speed, control and precision but may come with a higher initial cost and a more complex design than fluid power cylinders (either pneumatic or hydraulic). Given the growing demand for cost control, engineering and analysis at the front end of an application can reduce overall costs and result in automation systems with higher reliability, better performance, lower energy expenditures and less maintenance.

WHITE PAPER DOWNLOAD:

Download our white paper, **Top ten tips: How to specify electric rod-style actuators for optimal performance, reliability and efficiency**, for the full explanation.



INFOGRAPHIC

10 tips for specifying electric rod actuators



VIEW OUR WEBINAR

Learn about electric rod actuator selection at our webinar.

TRADITIONAL AND INTEGRATED ELECTRIC LINEAR ACTUATORS

A trend in electric linear motion is to integrate the control, drive, motor and other components with the actuator. This has created a new category: integrated actuators.

Pneumatic cylinders have been used widely because they are inexpensive to buy and simple to apply. Electric rod-style actuators are gaining popularity due to their flexibility and energy efficiency. However, electric rod actuators have been perceived as a more expensive and complex solution.

An integrated electric actuator offers advantages over both pneumatic and traditional electric actuator solutions. Compared to a pneumatic cylinder an integrated electric actuator will save energy. Compared to a traditional electric actuator an integrated solution will save purchase, installation, and assembly costs, while reducing the overall footprint of the machine.

WHITE PAPER DOWNLOAD:

Download our white paper, **Comparing traditional and integrated rod-style linear actuators: How to choose the best solution for motion control applications**, here.

Selecting the right actuator: Rod or rodless

(CONTINUED)

RODLESS ELECTROMECHANICAL ACTUATORS

SELECTION TIPS

Rodless electro-mechanical actuators have an advantage over electric rod actuators, as many have the ability to support and carry loads. This can reduce costs and design time by eliminating the need for other load-bearing and guiding elements. In contrast to rod-style actuators, a rodless actuator's stroke lies completely within the length of its body, resulting in a smaller working footprint. In addition, rodless actuators can be either screw- or belt-driven, with each drive type having its own advantages depending on the application.

WHITE PAPER DOWNLOAD:

Download our white paper, **Specifying electric rodless actuators: Ten tips for maximizing actuator life and system performance**, for the full explanation.

WHITE PAPER DOWNLOAD:

To learn more about drive train selection, download our white paper, **Screw-driven vs. belt-driven rodless actuators: How to select drive trains for reliability, efficiency and long service life.**

BELT DRIVE OR SCREW DRIVE?

Rodless electromechanical actuators commonly use one of two main drive train types to convert a motor's rotary motion to linear motion: a power screw drive or a timing belt drive. While both offer efficiency, reliability and long life, each has its limitations.

Power screw drives and timing belts carry a dual function. They are used for linear positioning, and they transmit power. A screw mechanism produces linear motion by rotating either the screw or the nut in an assembly. Similarly, timing belt drives transmit torque and linear motion from a driving pulley via the belt, which in turn moves the actuator's carriage.

The specifics of a motion control application determine which drive train to select. Key factors in drive train selection are length of stroke, linear velocity and acceleration, as well as orientation of the move. Drive trains vary in capacity, so the thrust of the actuator as well as load and force of the actuator carrier will affect drive train choice.

INFOGRAPHIC

10 tips for specifying rodless electric linear actuators



VIEW OUR WEBINAR

Learn about rodless electromechanical actuator selection at our webinar

Sold & Serviced By:

ELECTROMATE

Toll Free Phone (877) SERV098

Toll Free Fax (877) SERV099

www.electromate.com

sales@electromate.com

Tolomatic
EXCELLENCE IN MOTION

Selecting the right actuator: Rod or rodless

(CONTINUED)

SCREW SELECTION

When it comes to specifying an electric linear actuator it is critical to select the right lead screw for the application because the screw is the major drive component in most electric actuators.

There are three primary types of screws used in linear actuators: acme, ball and roller. The differences among these screw types are in the design of the thread shape along with the design and operation of a matching nut.

GUIDE DOWNLOAD:

Learn about terminology and the uses of each type of lead screw design in our guide, *Which screw? Picking the right technology*. Click here to download.



Sold & Serviced By:

 **ELECTROMATE**

Toll Free Phone (877) SERV098

Toll Free Fax (877) SERV099

www.electromate.com

sales@electromate.com

 **Tolomatic**
EXCELLENCE IN MOTION.

Selecting the right actuator: Rod or rodless

(CONTINUED)

CONSIDER THE ENVIRONMENT

The IP rating system standardizes ingress protection levels for enclosures and machine components like linear actuators. Electric actuators are used in manufacturing applications that can expose them to dust, liquids and chemical solutions. Generally, rod-style models are better suited to harsh conditions. Unshielded rodless actuators can be employed if conditions require a rating of IP54 or lower. For higher levels of ingress protection, rodless actuators often require external shields or enclosures.

When selecting linear actuators for applications that require dust and liquid ingress protection, consider the types of dust and liquids to which the actuators will be exposed. This will ensure environmental compatibility, optimal performance and long service life.

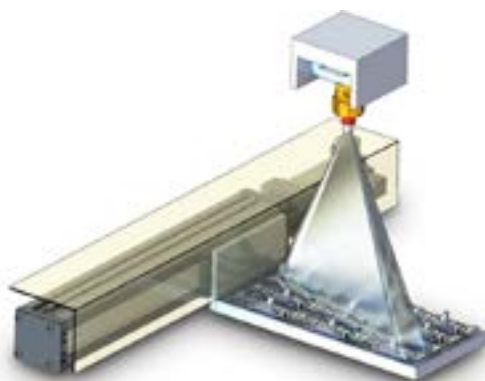

WHITE PAPER DOWNLOAD:

Learn more about the IP rating system and how it relates to linear actuator selection. Download our white paper, *IP ratings and the manufacturing environment: How to apply linear actuators for quality, safety and long service life.*

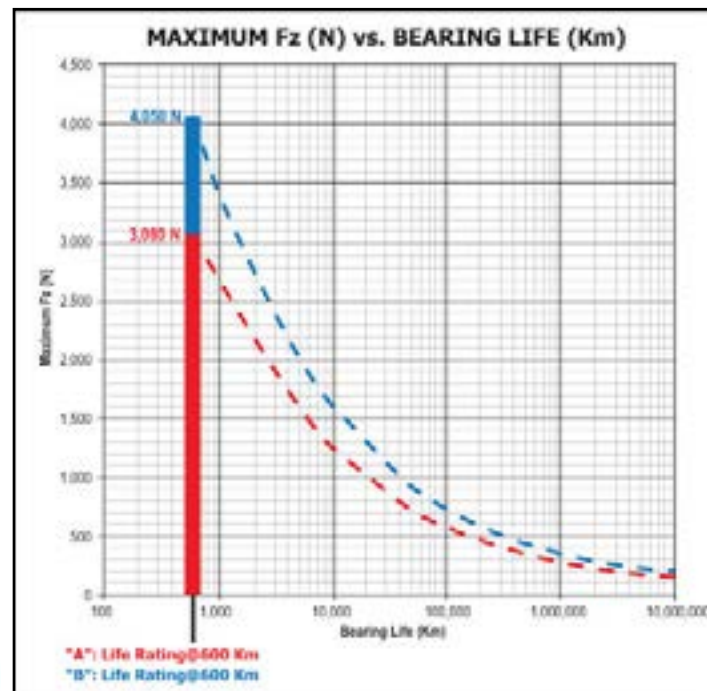

COMPARING MANUFACTURERS' SPECS

When it comes to electric linear actuator selection, a product that has the highest output rating—in loads, moments, or thrust—can have a distinct competitive advantage. Often the product that has the highest rating is seen to be the superior, most robust choice. However, what really counts is how long the actuator performs (that is, its useful life).

How can you use manufacturers' published specification ratings to make a meaningful comparison? In order to compare components, the specification values need to be normalized to the rated life of travel the actuator is capable of when external forces are applied. Then the resulting data can be evaluated in the same units of measure.

WHITE PAPER DOWNLOAD:

Our whitepaper, *Select the right linear actuator: making sense of manufacturer specifications*, explains how to normalize specs. Download it here.

Sold & Serviced By:



Toll Free Phone (877) SERV098
Toll Free Fax (877) SERV099
www.electromate.com
sales@electromate.com



Selecting the right actuator: Rod or rodless

(CONTINUED)

CALCULATING ACTUATOR LIFE

Determining the useful life of machines and their components is a fundamental challenge in any motion system design project. The useful life (or service life) of a machine or component like a linear actuator is the period during which it continues to operate and satisfy its required function.

The useful life of any actuator depends on the life of the components that perform most of the mechanical work or carry the most load. Lead screw drives are an example of such a critical component.

The life of a lead screw can be defined as the actual life achieved by a screw before it fails for any reason. Among possible reasons for failure are: fatigue, excessive wear, corrosion, contamination, insufficient structural strength, or loss of any function required by the application. ➔

WHITE PAPER DOWNLOAD:

Download our white paper, *The truth about actuator life: screw drive survival*, for examples of load-life conversion calculations.

WHITE PAPER DOWNLOAD:

What is DLR, L10 and Equivalent Load? How do they affect actuator life? Download our guide: *How to estimate life in ball and roller screw-driven actuators.*

SIZE IT RIGHT!

Wish specifying electrical linear actuators was easier? Our *electric actuator sizing software* could be just what you need. It's technology that'll save time and hassle when selecting actuators.

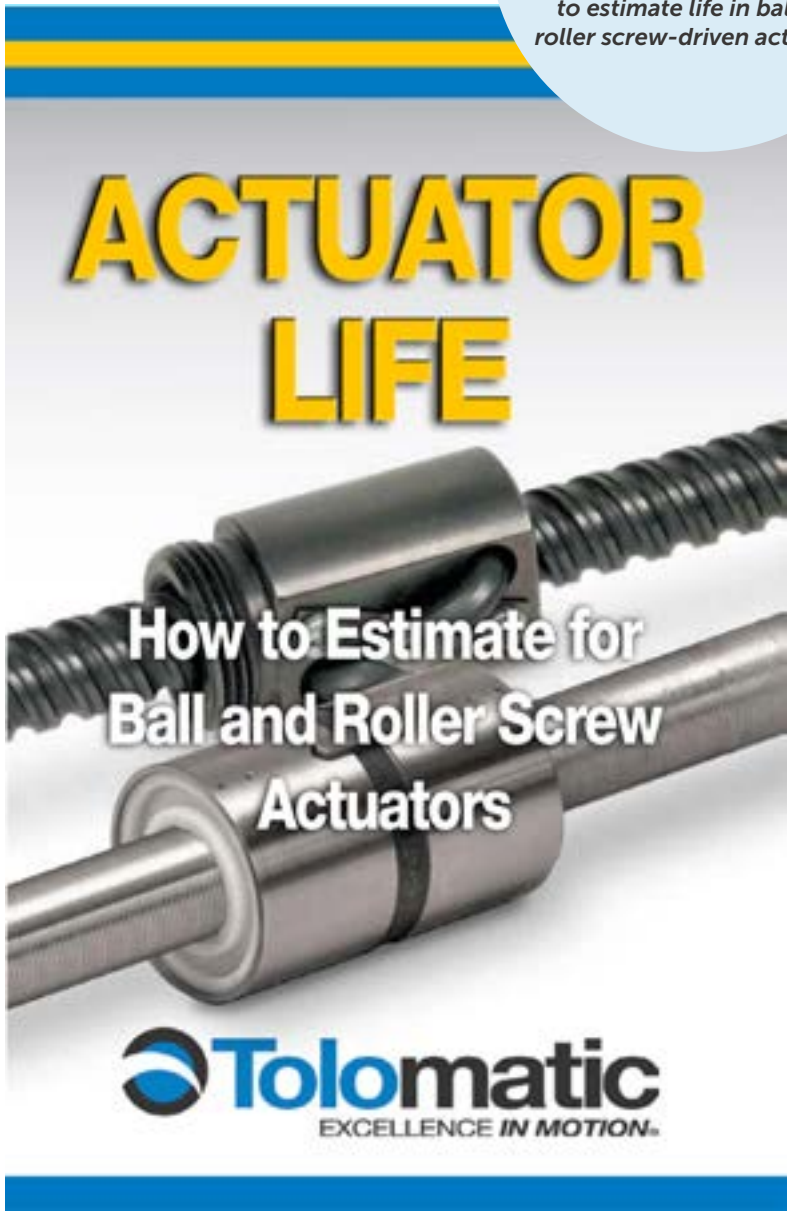

IV. Motor selection: Stepper or servo?

COURTESY OF TOLOMATIC

Electric linear actuators rely on motors to generate torque. Selecting the appropriate motor type is a major consideration when specifying an electric linear actuator. The decision must take into account the application's parameters. Two common motor options for electric actuators are stepper motors and servo motors. A machine designer needs to understand the advantages and disadvantages of both types in order to specify the best motor for an application

SERVO MOTORS

A brushless servo motor has three wiring phases in the stator. The rotor has several pairs of permanent magnets aligned with alternating poles. When the phase windings are energized, torque is generated between the phase's electromagnet poles and the rotor's magnetic poles causing the rotor to rotate. A servo motor is paired with some type of encoder to provide position and speed feedback. Servo actuators perform well in high speed and force-sensitive applications. They are closed loop devices and require the feedback of sensors plus additional cabling to connect to controllers.

SERVO MOTOR ADVANTAGES

- Higher degree of control over position and speed.
- Higher degree of accuracy due to closed loop control.
- Maintain torque throughout speed range; can output brief periods of "peak torque."

SERVO MOTOR DISADVANTAGES

- More complex and may cost more.
- Control loops may require tuning which adds complexity.



STEPPER MOTORS

A stepper motor is a brushless DC motor that divides a full rotation into equal steps. The rotor has magnetic teeth that align to the electromagnetic poles in the stator. The motor's position is known by the number of steps commanded. The motor's shaft can be commanded to move and hold at a step without any feedback sensor. Electric actuators with stepper motors offer excellent performance and lower cost for low speed, high torque and high repeatability applications with open-loop control.

STEPPER MOTOR ADVANTAGES

- Open loop position control. No feedback information needed.
- Lower cost.
- High torque at low speeds.
- Denture torque (the torque required to turn the motor when no current is applied to the windings) is much higher in stepper motors and is beneficial in preventing the weight of the load back-driving the motor when the system is powered down.
- Excellent repeatability. Accuracy within 3-5%.

STEPPER MOTOR DISADVANTAGES

- Insufficient torque can lower accuracy. Motor may be oversized (up to 50% above maximum torque requirement), leading to higher cost.
- Motor resonance is common resulting in torque loss and noise.



WHITE PAPER DOWNLOAD:

Download our white paper, *Choosing stepper- or servo-driven actuators to replace air cylinders*, for a thorough explanation.

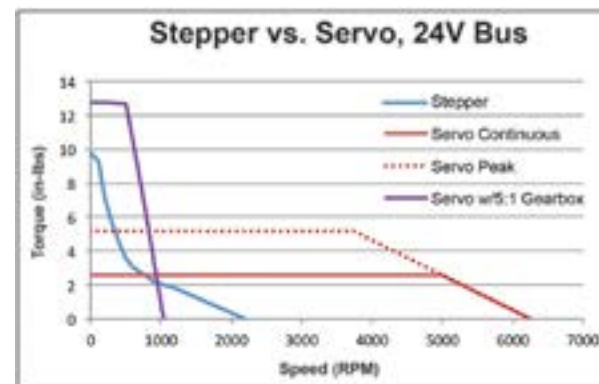

Sold & Serviced By:

 **ELECTROMATE**

Toll Free Phone (877) SERV098

Toll Free Fax (877) SERV099

www.electromate.com

sales@electromate.com

 **Tolomatic**
EXCELLENCE IN MOTION.

Motor selection : Stepper or servo?

(CONTINUED)

MOTOR MOUNTING

Attaching a motor to an electric linear actuator requires an adaptor or housing. The mounting hardware needed varies based on motor type and brand as well as on how the motor is to be mounted — either inline or reverse parallel.

An inline configuration directly couples the motor's driving shaft to the actuator through a housing. This configuration provides excellent motor support and allows maximum power transmission from the motor to the actuator. The downside, though, is that this type of configuration takes up horizontal space (length of motor + length of actuator).

A reverse parallel configuration is a space-saving alternative (on the horizontal plane); however, some of the motor's power will be lost due to the gear or belt drive required. This loss may reduce some of the actuator's force.

The needs of your application will help you decide on the appropriate configuration. ➔

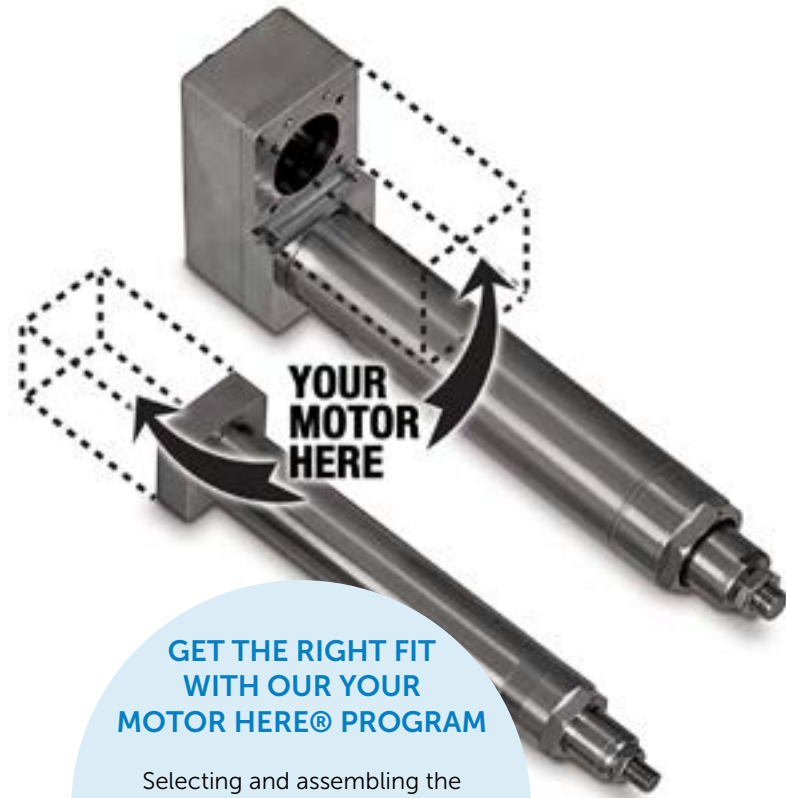

GET THE RIGHT FIT WITH OUR YOUR MOTOR HERE® PROGRAM

Selecting and assembling the components of an electric actuator system adds to your workload as a busy engineer. We developed the Your Motor Here® program to make it quicker and easier to match motor to actuator and get the right motor mounting hardware.



V. System installation: Considerations

COURTESY OF TOLOMATIC

OPTIMIZING ACTUATOR ALIGNMENT

Many industrial machines rely on linear guidance components, often driven by some type of linear actuator, to guide and support moving elements. Guidance components include profiled rail, round rail or other rolling or sliding bearing structures. However, guidance components can affect system performance and actuator life by introducing challenges such as:

- Inconsistent results
- Shorter-than-expected useful life
- Premature wear or failure of actuator components
- Erratic motion, such as speed variations or wobbling

When you are installing a linear motion system that includes guidance components, be sure actuator compliance mechanisms are in place to compensate for stress points. Also, you will need to address both parallelism in the system and perpendicular alignment bending moment issues. Careful consideration of these elements will give you optimal performance of the actuator and guidance system.

WHITE PAPER DOWNLOAD:

Our white paper, *Rules of actuator and guide alignment in linear motion systems*, provides an explanation of these installation issues. Download it here.

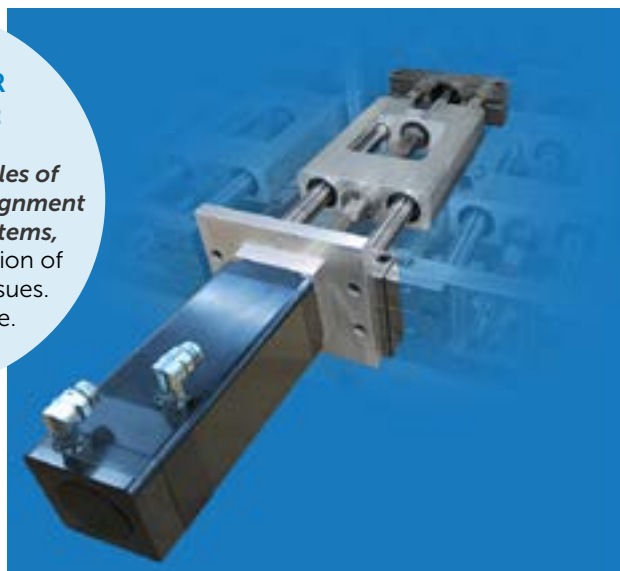

WHITEPAPER DOWNLOAD:

Our white paper, *Minimizing electrical noise in actuator drive systems for maximum reliability and performance*, discusses the causes of electrical noise, its effects on communication and how to minimize it. Download the paper here.

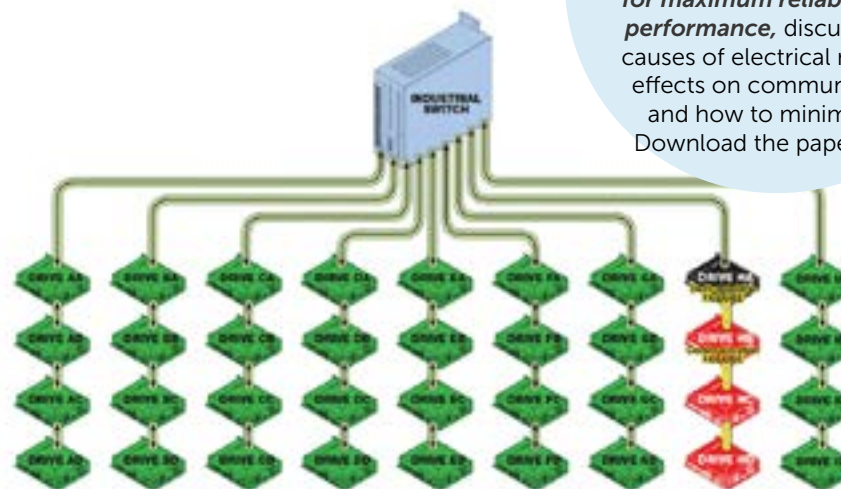

MINIMIZING ELECTRICAL NOISE

Electric drives and actuators operate in harsh conditions that subject equipment to electrical noise—a random fluctuation in an electrical signal that is present in all electronic circuits. Electrical noise can disrupt actuator control signals, cause erratic movements or precipitate complete system failure. By understanding electrical noise, system designers can take steps to minimize interference and ensure greater reliability.

A designer needs to consider two types of electrical noise: ground loop and induced noise. Both can be mitigated with appropriate installation, cable separation and shielding. Communications issues can be mitigated by minimizing noise and employing appropriate daisy chaining.

To avoid difficulties, we suggest considering issues with electrical noise and communication integrity early in the system design and installation process. Because electrical noise cannot be eliminated completely and a communication system can never be completely fail-proof, the primary objectives during system design/installation are to mitigate the risks associated with electrical interference and make informed financial decisions based on the operating environment and costs associated with potential system failure. 🔄

Sold & Serviced By:

 **ELECTROMATE**

Toll Free Phone (877) SERV098

Toll Free Fax (877) SERV099

www.electromate.com

sales@electromate.com

 **Tolomatic**
EXCELLENCE IN MOTION.

VI. Electric actuator applications: Improved efficiency

COURTESY OF TOLOMATIC

AUTOMOTIVE MANUFACTURING

As the global automotive industry continues to grow, demand for automated production is also expanding to control quality and production costs. As part of this move toward increased automation, many automotive manufacturers employ servo-controlled resistance spot welding equipment within their body-in-white production lines.

However, automobile manufacturers producing vehicles for markets including China, Brazil, Korea and India may still use traditional pneumatic spot welding equipment. As vehicle production in these markets ramps up and consumers demand higher quality, these manufacturers are considering a transition to robot-carried, servo-controlled spot welding equipment. Servo-actuated resistance spot welding guns provide better welds, require less maintenance, and offer lower operating costs, increased life and better return-on-investment (ROI) than their pneumatic counterparts.

WHITE PAPER DOWNLOAD:

For more information on the advantages of electric servo actuators over pneumatic actuators, download our white paper, *Servo spot welding offers superior performance and lower lifetime costs for auto manufacturing.*

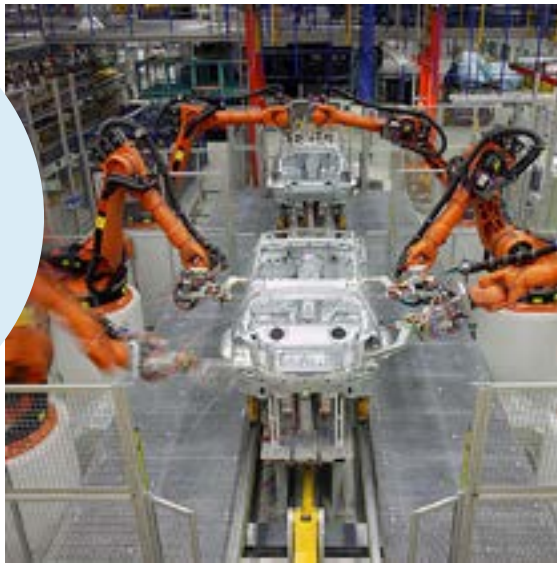

SEE THE SLIDESHOW:
How electric servo welding actuators can help reduce costs

PROCESS INDUSTRIES

Valves are critical components in processing plants because they control the flow of raw materials and finished goods. Some valve automation applications, especially control valves, require increasingly sophisticated motion control solutions. To meet these demands, engineers can use an emerging technology in valve actuation: brushless servo valve actuators.

Control valves operate in two ways: linear motion (rising stem) or rotary motion (half turn or quarter turn). Each method is designed for specific functions and applications. Rising stem valves are typically used in mission critical areas of a process where reliability, repeatability, accuracy and responsiveness are all desired. Brushless servo motion control can provide performance improvements beyond traditional actuation methods.

Electric linear valve actuators (both brush and brushless servo motor types) provide excellent control in valve applications. Electric actuator technology has evolved, bringing costs down, reducing the number of components, making set-up user friendly, and dramatically improving overall system efficiencies when compared to pneumatic and hydraulic systems.

WHITE PAPER DOWNLOAD:

For the full story download our white paper, *How to select the best linear actuator type for valve automation in process industries.*

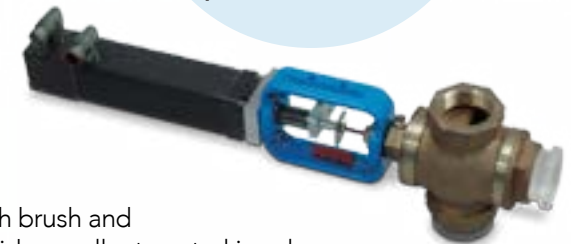

Sold & Serviced By:

 **ELECTROMATE**

Toll Free Phone (877) SERV098

Toll Free Fax (877) SERV099

www.electromate.com

sales@electromate.com

 **Tolomatic**
EXCELLENCE IN MOTION.

Electric actuator applications: Improved efficiency

(CONTINUED)

FOOD AND BEVERAGE PROCESSING

Production of food and beverages on today's industrial scale would not be possible without a high level of automation. Pneumatic, hydraulic and electric actuators are critical moving components in food and beverage processing and packaging equipment.



WHITE PAPER DOWNLOAD:

Our white paper, *Evaluating actuators for washdown in food & beverage applications*, discusses these issues fully. Download it here.

In addition to being efficient, machines used to process food must keep food safe by not harboring or introducing bacteria, lubricating fluids or other contaminants that could harm consumers. As part of food and beverage production machines, electric actuators must be manufactured from materials that resist corrosion while not leaching toxic substances into food products or packaging. Also, actuators need to be designed in a way that eliminates collection points where

bacteria can flourish. Suitable actuators must be capable of withstanding frequent washdowns with water, detergents, steam, caustic soda, citric acid or other types of sanitary cleaning solutions.

MATERIAL HANDLING

Material handling systems keep manufacturing processes moving. They bring raw materials to machines, take workpieces to new processes, and package, palletize and prepare finished goods for shipping. Every plant has some type of material handling need, and most plants have a range of systems, each with its own specifications. This means material handling encompasses an extremely wide variety of applications.

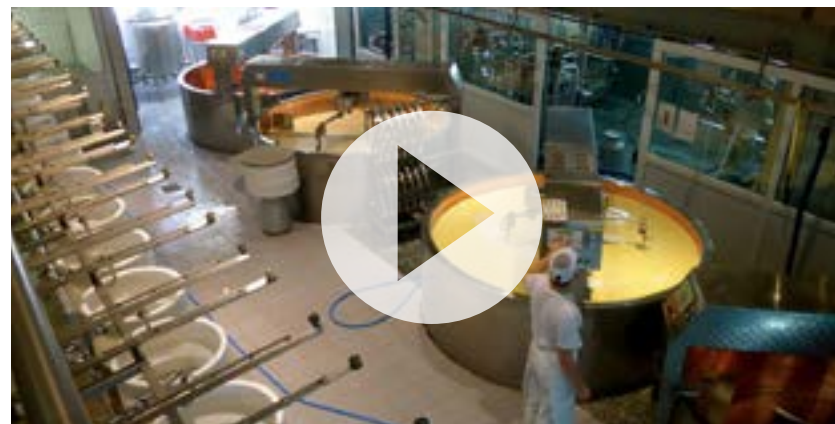

Food for thought:

Specifying linear actuators for food processing

Watch our video on what features and materials to look for.

Conveying equipment gets this material handling work done, often with the accurate and reliable functioning of linear actuators. When specifying linear actuators for material handling, consider the application's specific needs for positioning accuracy, energy efficiency and cost of ownership. If a facility produces several products, then actuators that are easily programmable to several positioning set-ups may be needed. Also, it is important to consider the manufacturing environment, both the presence of harmful moisture and dust and the use of harsh chemicals like those employed to wash down food processing equipment. Actuators must be able to withstand these conditions. 🔄

For stories of how we have worked with material handling equipment manufacturers to solve their challenges, download these case studies:

- *Tolomatic ERD electric actuators help global conveyor manufacturer Intralox make all the right moves*
- *Hytrol puts the skinny on bulky conveyor diverters with space-saving rodless cylinder from Tolomatic*

Sold & Serviced By:

 **ELECTROMATE**

Toll Free Phone (877) SERV098

Toll Free Fax (877) SERV099

www.electromate.com

sales@electromate.com

 **Tolomatic**
EXCELLENCE IN MOTION.

VII. Conclusion: Total cost of ownership

COURTESY OF TOLOMATIC

ELECTRIC VS. PNEUMATIC AND HYDRAULIC LINEAR ACTUATORS

In the final analysis cost is a major factor in the acquisition of any piece of automation equipment, but cost can be considered in different ways. Evaluating the cost of automation has evolved from an overly simplistic process to a more realistic one.

Purchase price often has been the only cost factor considered when buying an automation device. That practice is giving way, though, to a thorough analysis of the device's "total cost of ownership" (TCO). The TCO concept combines purchase price with the cost of operating the device over its projected service life.

When it comes to linear actuators, pneumatic actuators (air cylinders) are known for their low initial cost and durability. They have been a staple in factory automation equipment for decades because they are simple, easy to maintain and provide reasonable control over linear motion. Hydraulic actuators are known for their high force output and can be used where pneumatic power is not possible, but their characteristic of leaking fluid is becoming a concern in today's fragile outdoor environments. Since the development of more flexible, precise and reliable electric actuators with increased force capacities and greener, more efficient operation, there has been a debate over which technology offers the best overall solution for industrial plant optimization.

The case for switching to electric actuators has focused on the ability of electric actuators to achieve more precise control of motion (in terms of position, speed, acceleration and force), along with providing superior accuracy and repeatability. That superior performance, though, comes with a higher initial price.

While it's true that electric actuators have a higher initial cost, this is not the complete story. There are factors that can make an electric actuator a more economical option than an air or hydraulic cylinder over the life of a device or machine. These include efficiency, electric utility costs, air and hydraulic fluid leaks, maintenance, actuator replacement, product quality, changeover time, cycle times and contamination risks. These factors combined with purchase price determine the total cost of ownership for an actuator.

Considering TCO early in the process of specifying linear actuators means a machine designer will analyze the entire service life of a choice with related costs, as well as the initial purchase price. This analysis will show that in many cases choosing an electric actuator over a pneumatic or hydraulic device will provide a lower TCO, making the electric actuator the better choice. 🔄

WHITE PAPER DOWNLOAD:

*Electric rod actuators
vs. hydraulic cylinders:
A comparison of the
pros and cons of each
technology.*

WHITE PAPER DOWNLOAD:

*Electric actuators vs.
pneumatic cylinders:
A comparison based
on total cost of
ownership*

BLOG AND INFOGRAPHIC:

Read the Tolomatic blog for more information on *Calculating total cost of linear actuators.*

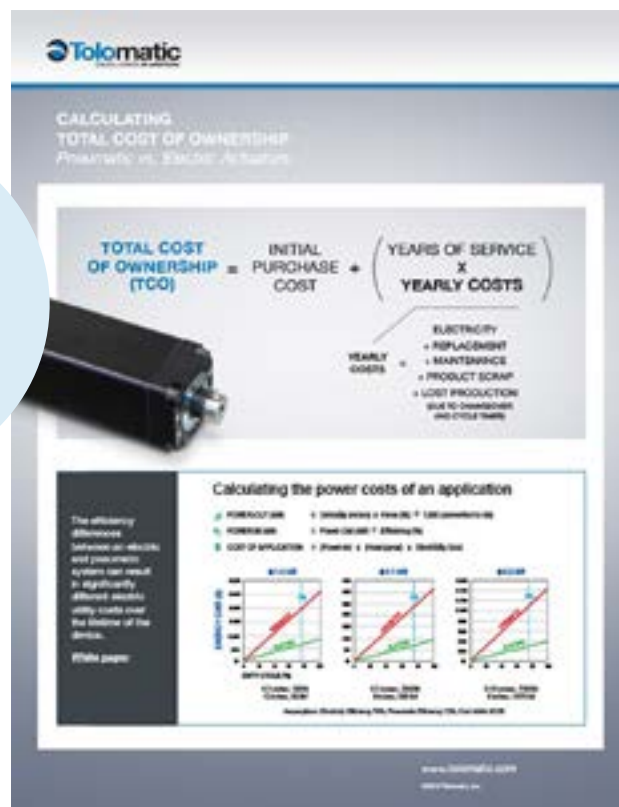

Sold & Serviced By:

ELECTROMATE

Toll Free Phone (877) SERV098

Toll Free Fax (877) SERV099

www.electromate.com

sales@electromate.com

Tolomatic
EXCELLENCE IN MOTION.